



ESD protection for USB2.0 ports

PRTR5V0U2X, PRTR5V0U2AX, PRTR5V0U4D

Handling data rates up to 480 Mbit/s, USB2.0 interfaces require ESD protection devices with an extremely low line capacitance in order to avoid signal distortion.

With a capacitance below 2 pF, Philips' PRTR5V0U2X, PRTR5V0U2AX and PRTR5V0U4D offer IEC 61000-4-2, level 4 compliant ESD protection.

The devices integrate ultra-low capacitance rail-to-rail ESD protection diodes as well as an additional ESD protection diode connected between ground and V_{CC} to prevent charging of the supply. To achieve the maximum ESD protection level, no additional external capacitors are required. PRTR5V0U2X and PRTR5V0U2AX in the small SOT143 package are designed to protect one USB2.0 port whereas PRTR5V0U4D in SOT457 (SC-74) package is intended to protect two USB2.0 ports.

PHILIPS

Features

- ESD protection of USB2.0 high speed ports
- Ultra low input to ground capacitance:
 - $C_{(I/O-GND)} = 1 \text{ pF}$ (PRTR5V0U2X / PRTR5V0U4D)
 - $C_{(I/O-GND)} = 1.8 \text{ pF}$ (PRTR5V0U2AX)
- Very high ESD robustness
 - U_p to 8 kV (PRTR5V0U2X / PRTR5V0U4D)
 - U_p to 12 kV (PRTR5V0U2AX)
- IEC61000-4-2, level 4 compliance
- Very low clamping voltage
- Very low leakage current
- Small SMD plastic packages

Applications

- USB2.0 ports
- Mobile and cordless phones
- Personal Digital Assistants (PDA)
- Digital cameras
- Wide Area Network (WAN) / Local Area Network (LAN) systems
- PCs, notebooks, printers and other PC peripherals

Application examples

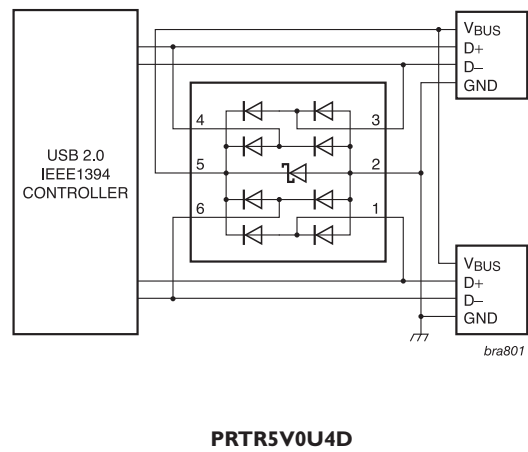
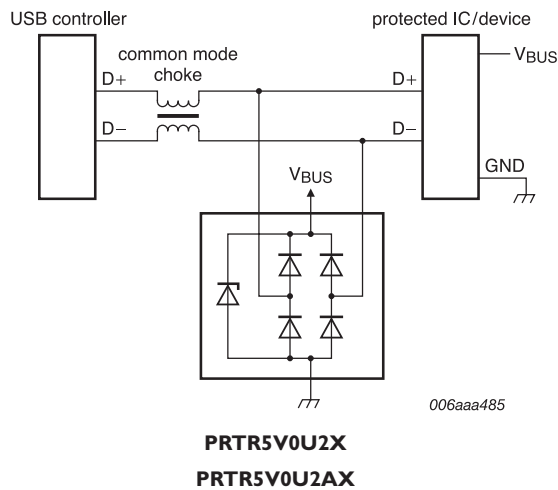



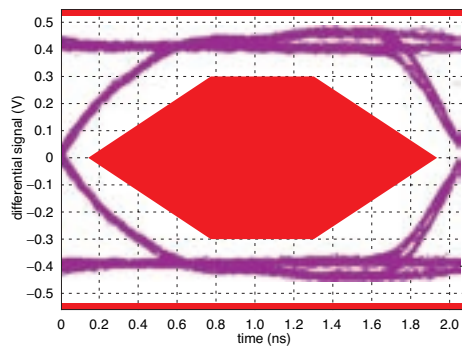

USB compliance test

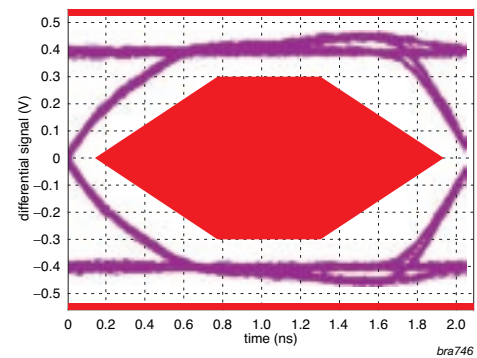

USB2.0 high-speed signal quality test for USB port (motherboard) **without PRTR5V0U2X**

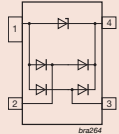

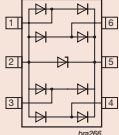
USB2.0 high-speed signal quality test for USB port (motherboard) **with PRTR5V0U2X**

Types and parametric data								
Number of protected data lines	I_R max [μ A]	@	V_R [V]	C_{line} typ [pF]	ESD rating* max [kV]	Configuration	Type	Package
2	0.1		3	1	8		PRTR5V0U2X	SOT143 2.9 x 1.3 x 1.0 
	0.1		3	1.8	12		PRTR5V0U2AX	
4	0.1		3	1	8		PRTR5V0U4D	SOT457 (SC-74) 2.9 x 1.5 x 1.0 

*acc. to IEC61000-4-2 (contact discharge)

Philips Semiconductors

PRTR5V0U2X

Maximum flexibility,
minimum space

Philips Semiconductors

PRTR5V0U2AX

Maximum flexibility,
minimum space

Philips Semiconductors

PRTR5V0U4D

Maximum flexibility,
minimum space

Philips Semiconductors

Philips Semiconductors is one of the world's top semiconductor suppliers, with 20 manufacturing and assembly sites and a sales organization that delivers in 60 countries. For a complete up-to-date list of our sales offices please visit our website <http://www.semiconductors.philips.com/sales> For the latest news from Philips Semiconductors, please register at: <http://www.semiconductors.philips.com/my>

©2005 Koninklijke Philips Electronics N.V.

All rights reserved. Reproduction in whole or in part is prohibited without the prior written consent of the copyright owner. The information presented in this document does not form part of any quotation or contract, is believed to be accurate and reliable and may be changed without notice. No liability will be accepted by the publisher for any consequence of its use. Publication thereof does not convey nor imply any license under patent- or other industrial or intellectual property rights.

Date of release: April 2006
Document order number: 9397 750 15448
Published in the Netherlands

